

# C.CRANE

# CCWiFi2

## Internet Radio



## INSTRUCTION MANUAL

PLEASE READ ALL THE INSTRUCTIONS COMPLETELY BEFORE USE  
AND SAVE THIS MANUAL FOR FUTURE REFERENCE

Revision 3 - 14

# Introduction/ Safety Instructions

---

## Thank you!

Thank you for purchasing a C.Crane CC WiFi 2 Internet Radio. We hope that you enjoy this radio as much as we do. If you have any questions or need more information about your radio, go to [www.ccrane.com](http://www.ccrane.com) or give us a call at 1-800-522-8863.

Technical Phone Support is available:

- Monday-Friday, from 9:00 a.m. to 5:00 p.m.

Or send us an Email:

- [customerservice@ccrane.com](mailto:customerservice@ccrane.com)

**PLEASE READ ALL THE INSTRUCTIONS COMPLETELY BEFORE USE AND SAVE THIS MANUAL FOR FUTURE REFERENCE**



**Before Use**



**Please read IMPORTANT SAFETY INSTRUCTIONS on page 43** before use. Please keep these precautions and instructions where all who use this radio will read them.

**For your future reference:**

Serial No. \_\_\_\_\_ Date of Purchase \_\_\_\_\_

Name & Address of Dealer \_\_\_\_\_

## Unpacking

The box should contain the CC WiFi 2, Remote Control, AC Adapter, Warranty Card and this Manual. If anything is missing or damaged, please contact your dealer immediately.

We recommend you keep the box in the unlikely event your radio needs to be serviced.

# Table of Contents

---

Unpacking .....	2
Location of Controls - Radio.....	4
Location of Controls - Remote.....	5-7
Connecting to the Internet.....	8
The Home Menu Screen.....	11
Using Internet Radio.....	11
Browsing Radio Stations.....	12
Searching for a Specific Radio Station.....	13
Setting the Radio Presets - TuneIn Radio.....	14
Recalling the Radio Presets - TuneIn Radio.....	15
Using Web Presets - TuneIn Radio.....	15-17
Playing a Station from History - TuneIn Radio.....	17
Using Media Center.....	17-21
Using FM Radio.....	21-23
Using Information Center.....	23-24
Using Aux to Connect a Player.....	24
Using Bluetooth™ to connect to a Player.....	24-25
Configuring Your Radio.....	25
Setting up the Radio on an Internet Network.....	25-26
Setting the Date and Time.....	26-27
Setting the Alarm.....	27-28
Other Settings.....	28-31
Troubleshooting and FAQs.....	32
Optional Accessories.....	33

# Location of Controls - Radio

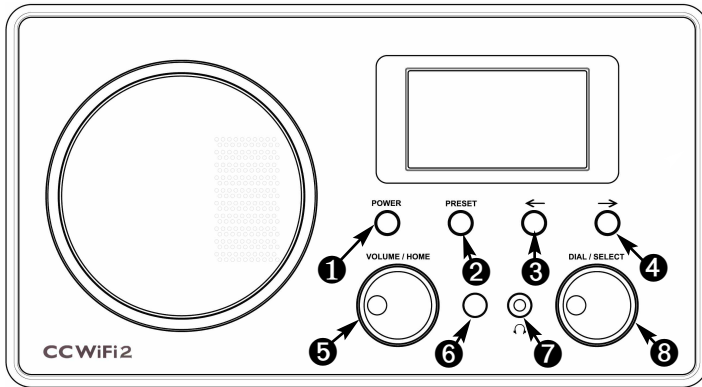

FRONT

- |                         |                             |
|-------------------------|-----------------------------|
| <b>1</b> Power Button   | <b>5</b> Volume / Home Knob |
| <b>2</b> Presets Button | <b>6</b> Remote Sensor      |
| <b>3</b> Left Arrow     | <b>7</b> Headphone Jack     |
| <b>4</b> Right Arrow    | <b>8</b> Dial / Select Knob |

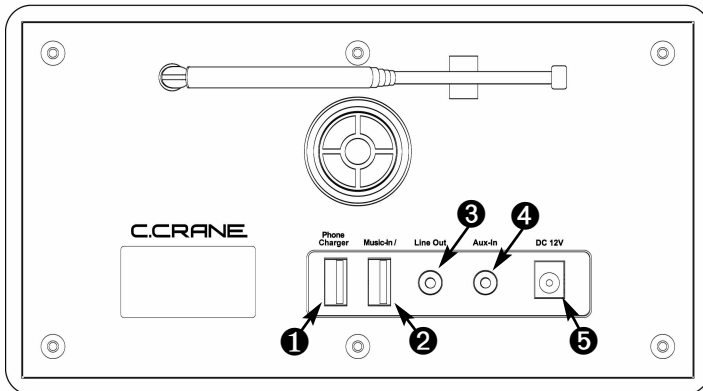

BACK

- |  |                              |
|--|------------------------------|
| <b>1</b> USB Phone Charging Jack             | <b>3</b> Line-Out Jack       |
| <b>2</b> USB Flash Drive or LAN Adapter Jack | <b>4</b> Aux-In Jack         |
|  | <b>5</b> Power Jack (DC 12V) |

## Location of Controls - Remote

- 1** Power: Turn radio ON or OFF.
- 2** MUTE: Mute or unmute the audio.
- 3** Memory Buttons 0-9:
  - Recall a memory preset.
  - Save a memory preset. (First press and hold the “Star” button for 3 seconds).
  - Use the alphabet below these buttons to enter your password, username, or station name.
- 4** Dimmer: Change the screen brightness.
- 5** Star: (same as “Preset” button).
  - Press once quickly to view radio presets
  - To save a station to memory – (Press and hold for 3 seconds, then use the number buttons or dial to choose the memory slot desired)
- 6** Left and Right Arrows:
  - Move to next or previous menu screen
  - Delete previous letter or move to next space in word or password entry mode
  - Edit presets – (Press the right arrow button while in “Browse Presets” screen)(Continued)

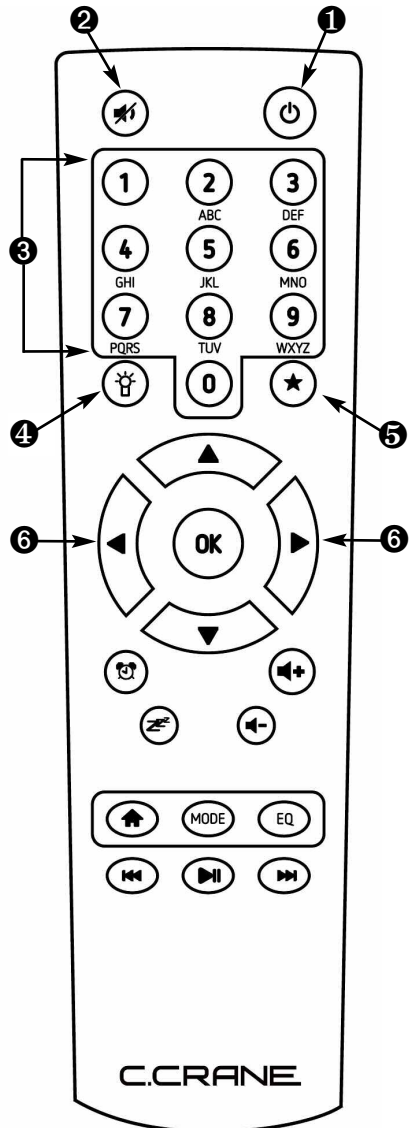

## Location of Controls - Remote (Continued)

- Add a preset:  
(Press the left arrow button and then the right arrow button).
- Automatically tune to next or previous station in FM Radio mode.

**7** Up and Down Arrows: (same as dial knob).

- Highlights next or previous item in a menu screen.
- Scroll through letters, numbers, and special characters in word/password entry mode.
- Plays next or previous station or song in the selected list.
- Manually tunes FM Radio.

**8** OK: (same as "Select" button).

- Selects a highlighted menu item.
- Submits your word/password entry.
- Returns to previous station list while playing a station.
- Confirms preset entry from the number pad.
- Automatically sets all available stations to memory while in FM Mode (Hold button for 3 seconds to activate this feature).

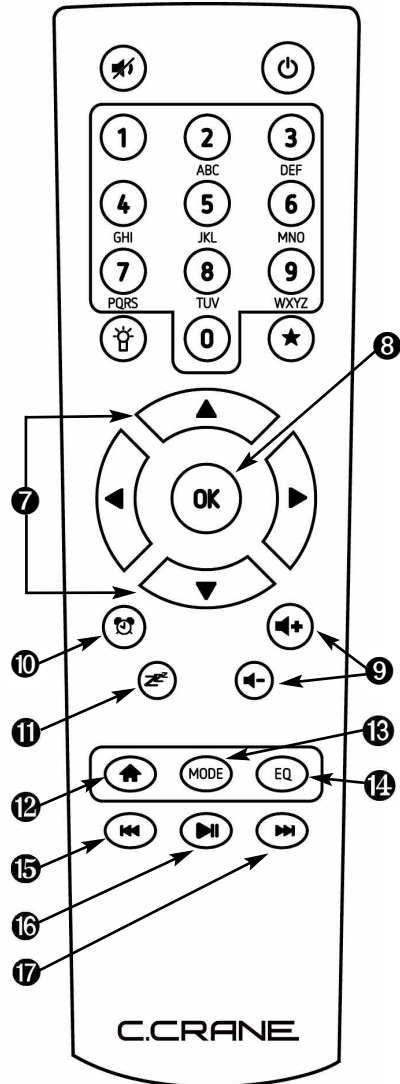

## **Location of Controls - Remote (Continued)**

---

- 9** VOLUME +/-: Adjust volume.
- 10** ALARM: Set two alarms, a nap timer, or alarm volume.
- 11** SLEEP: Set sleep timer to turn off radio in 15, 60, 90, 120, 150, or 180 minutes.
- 12** HOME: Go to main menu (press once) or go back to playing station info (press twice).
- 13** MODE: Switch between iRadio, FM, AUX, Bluetooth, UPnP, and USB mode.
- 14** Equalizer: Adjust sound for Normal, Flat, Jazz, Rock, Movie, Classical, Pop, or News (the news setting is best for talk radio).
- 15** Skip Back: Play previous station or file.
- 16** PLAY/PAUSE: Play or pause track.
- 17** Skip Forward: Play next station or file.

## Turning Your WiFi Radio On

---

1. Plug the power adapter cube into a 120V AC power outlet. Connect the power adapters small plug into the jack on the back of the radio that is labeled “DC 12V”.



*Caution: Only use the power adapter supplied with the radio. Connecting a power adapter other than the one that was supplied with your radio could cause permanent damage to the radio and may be hazardous.*

2. After a few seconds the display on the front of the radio will light up and show “C.CRANE” followed by a language selection screen.

3. Rotate the knob labeled “DIAL/SELECT” to choose your language. Select your language by pressing the “DIAL/SELECT” knob, or by pressing the “OK” button on the remote control.

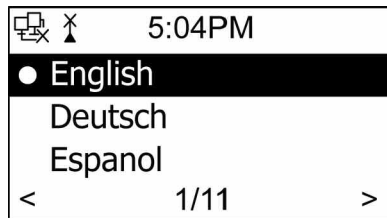

*Note: Both knobs on the front of the radio are buttons also. They can be rotated or pressed in.*

4. Press the “DIAL/SELECT” knob again to confirm “Check Network When Power On”. This will insure the best continuous performance.

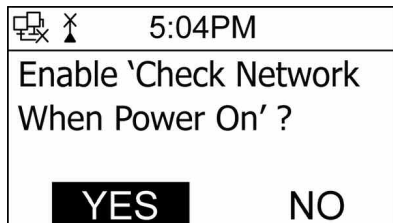



# Connecting to the Internet

1. If you have a newer router with a WPS button on the router then choose "YES (WPS)".

If your router does not have a WPS button, then choose only "YES".

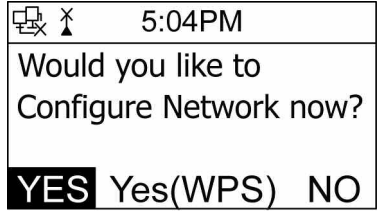

2. If you chose "Yes (WPS)" then this screen will appear. Press the button on your router to complete the wireless network setup. Please wait as the radio finalizes the connection to your router. This can take a minute to complete. Continue on page 11.

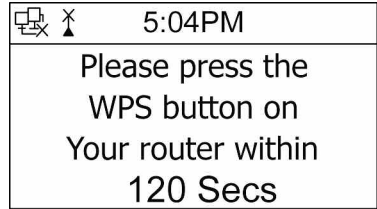

3. If you chose "YES" then this screen will appear. Rotate the dial and choose "Wireless" to connect to the router wirelessly.

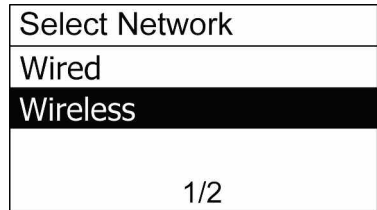

*Note: To connect to your router using an ethernet cable, connect the USB-to-LAN adapter (sold separately) to the port labeled "Music In"*

*on the back of the radio. Next, connect an Ethernet cable (sold separately) between the USB-to-LAN adapter and your router. Lastly, choose "Wired" as per the screen above. Continue on page 11.*

4. After scanning for wifi networks, the radio will display the names of networks found within range.



## Connecting to the Internet

---

Rotate the dial and choose the name of your network or router, then press the SELECT button.

 WiFi Signal Strength Indicator

 Requires password to connect

< 1/11 > Number of networks detected

5. If the network requires a wireless password before connecting, then you will see this screen. To enter the password, rotate the DIAL until the first character of the password is showing, then press the → button to begin selecting the next character. When finished, press the SELECT button to submit. To erase, press the ← button.

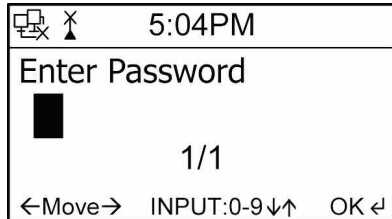

The remote control also offers a faster way to enter the wireless password using the number buttons. Notice the letters printed under each number button. For example: To enter “BigRig405” you would begin by pressing the “2” button several times until the upper case “B” is showing. Then press the → button. Next press the “4” button several times until the lower case “i” is showing, and so on...

For special characters like “\$”, press the “1” button. When finished press the “OK” button to submit.

*Need Help? See page 32 for help finding your wireless password.*

6. The radio will now attempt to connect to the network. This process may take up to a minute to complete.

*Note: When the radio is connected to the wireless network, a small antenna icon will appear at the top-left of the screen. This icon will be animated letting you know that you are now connected wirelessly.*

The WiFi signal strength icon will indicate one, two, or three bars to show how strong your connection is between the radio and your WiFi router. The ethernet icon will let you know when you are connected with an ethernet cable.

If the radio cannot connect to the network, then this screen may be displayed. Try placing the radio closer to the WiFi network. Also check the wireless password and make sure that it is correct. The wireless password is case specific and needs to be entered precisely.

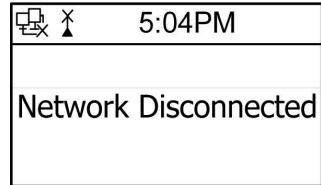

To play internet radio you must be connected either wirelessly or wired to an internet network. FM, Bluetooth, Aux-in, and USB modes do not require an internet connection to work.

## The Home Menu Screen

Note: This is the Home Menu Screen. Return here at any time by pressing the Home button on the radio or remote control. To return to a station that is already playing, press the home button twice.

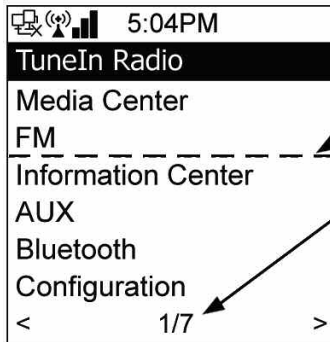

Rotate dial to see options below this line

There are seven options in the Home menu. The first option is currently highlighted for selection.

## Using Internet Radio

The CC WiFi 2 Internet Radio can play thousands of stations from around the world.

To find an Internet radio station, press the SELECT button (by pushing in the dial knob) while "TuneIn Radio" is highlighted.

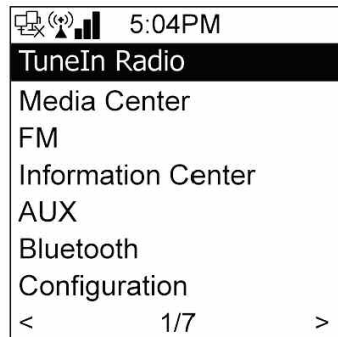

## Browsing Radio Stations

---

Select “Browse Stations” to narrow your search by category; such as Local Radio, Music, Talk, Sports, By Location, By Language, and by Podcasts.

*Note: If you are looking for a specific station, topic, artist, genre, show, or host, you can directly enter the name into “Search Stations”. See page 13 for more information.*

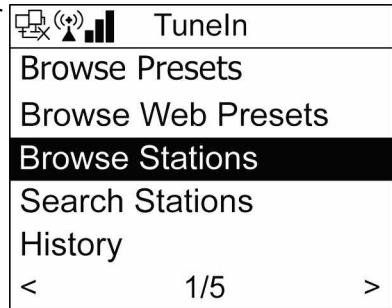

There are many selections possible depending on your preference. This manual will give a few examples of how to browse stations...

**Example #1** – Finding talk radio shows featuring paranormal topics:

Select “**Talk**”, then select “**Entertainment**”, then select “**Explore Entertainment**”, then select “**Paranormal**”, then select “**Shows**”.  
Now make your selection from the list.



**Example #2** – Finding “Easy listening” music from Belgium:

Select “**Music**”, then select “**Easy Listening**”, the select “**Explore Easy Listening**”, then select “**By Location**”, then select “**Europe**”, then select “**Belgium**”. Now make your selection from the list.

**Example #3** – Finding TV audio for News shows:

Select “**Talk**”, then select “**News**”, the select “**Explore News**”, then select “**TV News**”, then select “**Shows**”. Now make your selection from the list.

*Note: You can use your computer to browse the station list by going to [www.tunein.com](http://www.tunein.com). You can also setup your radio's Web Preset list from your computer after you have created a free account. Unfortunately, some stations will only be playable from [tunein.com](http://tunein.com) because of format and licensing requirements. See page 15 for more information.*

## Searching for a Specific Radio Station

---

To enter a search for a specific station, topic, artist, genre, show, or host, you can directly enter the name into the "Search Stations" area that is located in the "TuneIn Radio" menu.

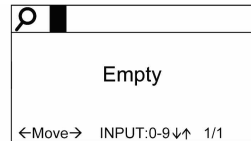
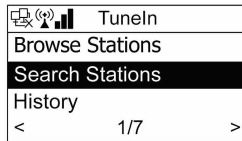
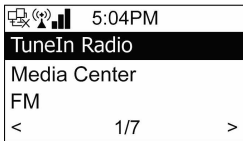

1. Rotate the DIAL until the first letter of the word that you want to search for is showing, then press the → button.
2. Rotate the DIAL until the second letter is showing, then press the → button. Continue this process until your word is complete. When finished, press the SELECT button to submit. To erase, press the ← button.

*Note: The remote control offers a faster way to enter your search by using the number buttons. Notice the letters printed under each number button on the remote control.*

*Example: To enter the word "ELVIS" you would begin by pressing the "3" button three times until the letter "E" is showing. Then press the → button. Next, press the "5" button four times until the "L" is showing, and so on... For special characters like "\$", press the "1" button. When finished press the "OK" button to submit.*

3. After you have submitted your search term, you will be presented with a list of choices related to the word or words that you have entered.

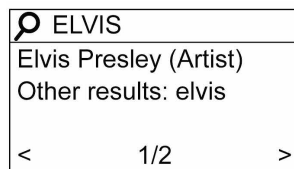

## Setting up Memory Presets - TuneIn Radio

---

Save your favorite stations into memory for quick access later on. When a station is saved (preset) it is stored in the “Browse Presets” list. There are 20 memory preset slots available for internet radio and 20 memory preset slots available for FM radio.

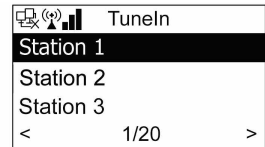
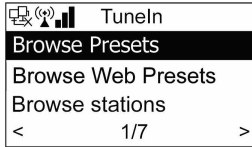
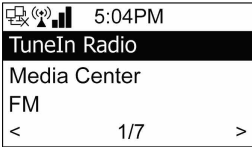

There are a few different ways for presetting a station into memory;

### *Using the radio:*

- **Method 1:** While playing a station, press and hold the “PRESET” button for two seconds. The screen will show “000”. Rotate the DIAL and choose a memory slot to store the station, then press “SELECT”.
- **Method 2:** While playing a station, press the ← button, then press the → button. Choose “Add to Preset” from the list, then press “SELECT”. This will store the station into the next empty memory slot until 20 stations are saved.

### *Using the remote control:*

- **Method 1:** While playing a station, press and hold the “STAR” button for two seconds. The screen will show “000”. Press the up or down arrow buttons (or use the number buttons) to choose a memory slot to store the station. Press “OK” when finished.
- **Method 2:** While playing a station, press the ← button, then press the → button. Choose “Add to Preset” from the list, then press “OK”. This will store the station into the next empty memory slot until 20 stations are saved.

*Note: you cannot preset a station that is being played from the “Web Presets” menu.*

## Recalling Radio Presets - TuneIn Radio

---

### *Using the radio:*

- Press the “PRESET” button once quickly to access a list of your saved radio presets. Rotate the dial and choose which preset you would like to play from the list, then press the “SELECT” button to begin play.

### *Using the remote control:*

- **Method 1:** Press the “STAR” button once quickly to access your radio presets. Press the up or down arrow to choose which preset you would like to play, then press the “OK” button to begin to play.
- **Method 2:** Enter the preset number for your desired station using the number keypad. After a few seconds the station will begin to play.

## Using Web Presets - TuneIn Radio

---

Add your favorite stations from [www.tunein.com](http://www.tunein.com) using your computer to your radios “Web Presets” list:

1. Using your computer, browse to [www.tunein.com](http://www.tunein.com) and create a free account by selecting the "Sign Up" button at the top of the page. It is best to make the password using your 10 digit phone number (or other number) to save time when entering it on the radio later.
2. While logged in to your Tunein account, find and play the station that you want to save.
3. While the station is playing, find the "Heart" icon at the bottom of the screen and click it to save the station to your web presets.
4. Using your radio, press the HOME button once to enter the home menu screen.

(Continued)

## Using Web Presets - TuneIn Radio (Continued)

---

5. Rotate the DIAL until "Configuration" is highlighted, then press "SELECT".

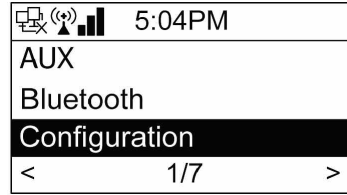

6. Rotate the DIAL until "Login TuneIn" is highlighted, then press "SELECT".

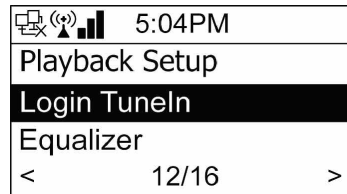

7. Press SELECT when "Login TuneIn" is highlighted.

8. Enter the username or email address that is associated with your online TuneIn account. To enter the username you can use the dial and arrow keys or the number/letter buttons on the remote control. Be sure that your username is entered with the correct case (upper case or lower case). When finished press SELECT.

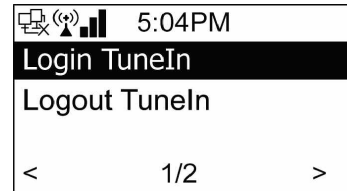

9. Enter the password that is associated with your online Tunein account, then press SELECT.

After you have successfully entered your username and password you will be able to play saved stations from your online TuneIn account from the "Web Presets" menu on the radio.

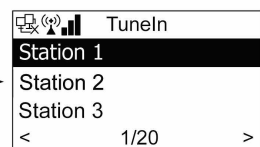
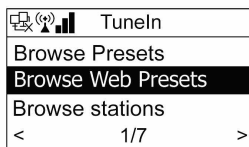
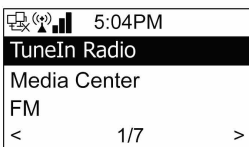



## Using Web Presets - TuneIn Radio (Continued)

---

*Note: Some stations will only be playable from tunein.com using your computer because of formatting and licensing requirements. These unavailable stations will usually open in a separate popup player when playing them from Tunein.com with your computer.*

## Playing a Station from HISTORY – Tunein Radio

---

The radio will remember your previous 10 stations played and will offer you quick access to these stations from the "History" menu.

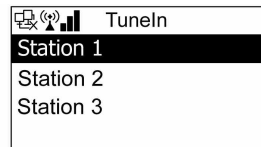
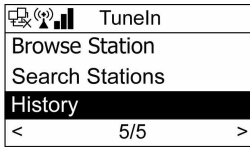
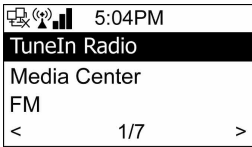

Rotate the dial (or press the up or down arrows on the remote control) to select a station, then press the SELECT button (or "OK" button on the remote control) to begin play.

## Using Media Center

---

### Playing audio from a USB Flash Drive:



1. Insert USB flash drive to the USB port on the back of the radio that is labeled "Music In".

*Note: After plugging the USB flash drive, a USB symbol icon will appear in the top-right corner of the screen indicating that the drive is ready. It may take several seconds for the USB symbol to appear.*

2. From the Home menu screen, select "Media Center", then select "USB".

(Continued)

## Using Media Center (Continued)

---

3. The radio will display the folder structure and playable contents of the USB flash drive.

### Media Center Controls:

- ▶▶ Play next song, or rotate “Dial” knob clockwise.
- ◀◀ Play previous song, or rotate “Dial” knob counterclockwise.
- ▶|| Play or Pause song.

To stop song, press “OK”, or push the “Dial” knob.

### Playing audio from a Computer or UPnP server:

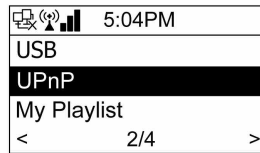
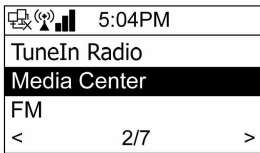

Before the radio can play audio that is stored on a computer, the computer will need to be setup to allow UPnP access to the radio. This process will be different depending on what computer operating system you are using;

### Windows 7-8 Users:

1. Open “Network and Sharing Center” from the control panel.
2. From the left pane, click “Change advanced sharing settings”.
3. Click the option to “Turn on network discovery”.
4. Next look for the “Media Streaming” section and be sure that “Media Streaming is on”. If it is not, then click “Choose media streaming option”, then “Turn on media streaming”.
5. Click “Save changes” at the bottom of the screen.
6. Restart your computer.

From the radio:

7. Unplug power from Radio for 10 seconds. Then power on the radio again.

(Continued)

## Using Media Center (Continued)

---

8. Select “Media Center” from the home menu, then select “UPnP”, then select your computer from the UPnP list.
9. Select “Music”. At this point, you will be able to browse the stored audio on your computer.

### **Windows Vista Users:**

1. Open “Network and Sharing Center” from the control panel.
2. Click the drop down arrow next to “Network discovery”.
3. Click the option to “Turn on network discovery”.
4. Click “Apply” button below this section.
5. Restart your computer.
6. Open Windows Media Player 11.
7. Right-click the black bar at the top of Windows Media Player 11 and select “Tools” > “Options” > “Library” tab > “Configure Sharing” > “Settings”
8. Check the box that says “Allow new devices and computers automatically (not recommended)”, then click “OK”.

From the radio:

9. Unplug power from Radio for 10 seconds. Then power on the radio again.
10. Select “Media Center” from the home menu, then select “UPnP”, then select your computer from the UPnP list.
11. Select “Music”. At this point, you will be able to browse the stored audio on your computer.

### **Windows XP Users:**

1. Open Windows Media Player 11
2. Right-click the black bar at the top of Windows Media Player 11 and select “Tools” > “Options” > “Library” tab > “Configure Sharing” > “Settings”
3. Check the box that says “Allow new devices and computers automatically (not recommended)”, then click “OK”.

From the radio:

4. Unplug power from Radio for 10 seconds. Then power on the radio again.
5. Select “Media Center” from the home menu, then select “UPnP”.
6. Select your computer from the UPnP list, then select “Music”. At this point, you will be able to browse the stored audio on your computer.

(Continued)

## Using Media Center (Continued)

---

If your computer did not show up in the UPnP list then continue with the remaining steps 7-16.

From the computer:

7. Open the "Control Panel" from the "Start" menu.
8. Open "Add or Remove Programs" and click "Add/Remove Windows Components" from the pane on the left.
9. Scroll down and click on the words for "Networking Services" to highlight it, then click the "Details" button below.
10. Be sure that the "Internet Gateway..." and "UPnP User Interface" are checked, then click the "OK" button at the bottom of the screen.
11. Click the "Next >" button and follow the wizard for installing a new component.
12. Now you can start the UPnP service. To do this, click the "Start" button, then click "Run", then type "services.msc", then press "OK".
13. Find the "SSDP Discovery Service" and open it by double clicking on it.
14. Change the "Startup type" to "Automatic" from the drop down list, then click "Apply", then "OK".
15. Restart your computer.
16. Repeat steps 1-4 (on Page 19) again.

*Note: If your radio is still having trouble accessing your computer then make sure that "UPnP" is enabled on your router. Also be sure that your computer and radio are connected to the same router or access point. There may also be a firewall or software security program on your computer that is blocking access from your radio.*

## Playing Audio from My Playlist

---

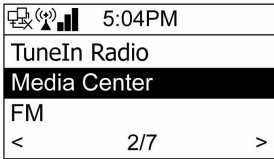

“My Playlist” lets you add your favorite songs from the UPnP player (explained on page 18) to a custom playlist. While browsing audio titles in “UPnP” press and hold the “DIAL/SELECT” button (or “OK” button on the remote control) until an icon appears on the top of the screen. The selected song will now be listed in “My Playlist”.

To clear “My Playlist”, select “Clear My Playlist” from the “Media Center” menu list.

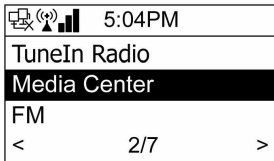

## Using FM Radio

---

Receive local broadcasts over the air with FM Radio. From the home menu screen, rotate the DIAL and select “FM”

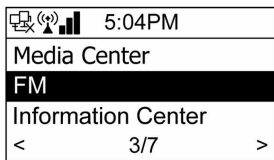

Fully extend the FM whip antenna from the back of the radio and position vertically. This antenna will only improve local FM radio reception.

## Using FM Radio

---

Manually Tune – Rotate DIAL, (or use up and down arrows on remote)  
Scan Tune – Press the ← or → buttons, (or left and right arrows on remote).

### Setting FM Radio Presets

---

#### ***Automatically set FM Presets:***

The radio has the ability to automatically set up all FM presets with one button push. Press and hold the SELECT button on the front of the radio (or the "OK" button on the remote control) for two seconds. The radio will scan the FM band and preset all available local stations in order.

#### ***Manually set an FM Preset - Using the buttons on the front of the radio:***

While playing a station, press and hold the "PRESET" button on the front of the radio for two seconds. The screen will show "000". Rotate the "DIAL" and choose a memory slot to store the station, then press "SELECT".

#### ***Manually set FM Presets - Using the remote control:***

While playing a station, press and hold the "Star" button for two seconds. The screen will show "000". Press the up or down arrow buttons (or use the number buttons) to choose a memory slot to store the station, then press "OK".

### Recalling FM Radio Presets

---

#### ***Using the buttons on the front of the radio:***

Press the "PRESET" button once quickly to access your radio presets. Rotate the dial and choose which preset you would like to play, then press the "SELECT" button to begin play.

#### ***Using the remote control:***

- **Method 1:** Press the "Star" button once quickly to access your radio presets. Press the up or down arrows to choose which preset you would like to play, then press the "OK" button to begin play.

## Using FM Radio

---

- **Method 2:** Enter the preset number for your desired station using the number keypad. After a few seconds the station will begin to play.

## Using the Information Center

---

View the local weather report, stock market averages, and technical information about your radio. From the home menu screen, rotate the DIAL and select “Information Center”.

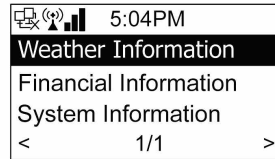
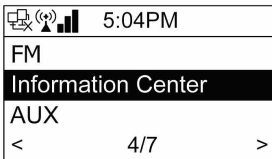

### *Viewing the Weather from around the world:*

Select “Weather Information” then choose your desired continent, then country, then city. Only 200 cities are displayed per country, so you may need to select the closest large city instead of your exact location.

The current temperature is displayed beneath the name of the city with a weather icon to show sunny, rainy, partly cloudy, etc. The weather forecast for tomorrow with expected highs and lows will show below. Rotating the DIAL will show you the forecast for the next few days.

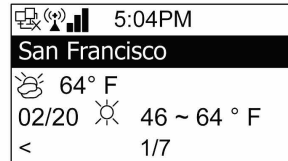

To add the city's current weather to your radios power-off screen, highlight the name of the city and press the SELECT button twice. When the power is pressed and the radio is in standby mode, the screen will interval between time and weather every 10 seconds.

### *Viewing Stock Market Averages:*

“Financial Information” will display the current points along with loss or gain amounts. Twelve popular stock exchanges from around to world are displayed. Rotate the DIAL to scroll through all of the stock exchanges.

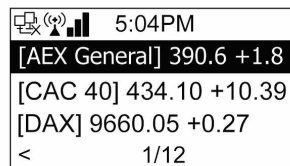

## Using the Information Center

---

### Viewing System Information:

“System Information” will display technical information about the radio, including firmware versions, IP information, current network name, and MAC addresses.

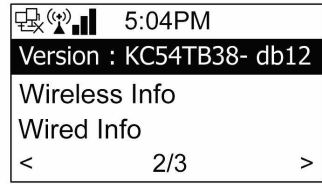

### Using AUX to connect a player:

---

Use the radio's speaker to amplify audio from your portable player or other device with AUX. From the home menu screen, rotate the DIAL and select “AUX”.

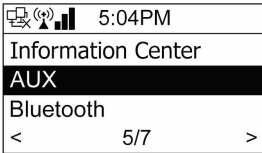

Connect an 1/8 inch stereo patch cable (sold separately) between the headphone jack (or line-out jack) of your device and the “Aux-In” jack of the radio.

The volume is controlled by the radio and also by your device. It is best to set the volume to medium on both to begin with. Use the controls on your device to navigate and play audio.

### Using Bluetooth® to connect a player

---

Send audio from your mobile phone or tablet to the radio via wireless Bluetooth technology. Bluetooth usually has a range of about 20 feet without obstructions. From the home menu screen, rotate the DIAL and select “Bluetooth”.

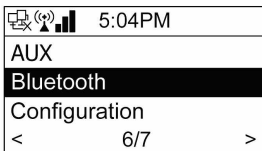



## Using Bluetooth® to connect a player (Continued)

---

Depending on your phone or tablet, navigate to the Bluetooth settings screen and scan for devices. Select “CCrane Radio” from the list. Your device will make a connection to the radio and then it will be ready to play your audio wirelessly.

The volume is controlled by the radio and also by your device. It is best to set the volume to medium on both to begin with. Use the controls on your device to navigate and play audio.

To exit Bluetooth mode, press the HOME button on the radio or MODE button on the remote control.

## Configuring your radio

---

There are many settings that can be adjusted from the “Configuration” menu. This includes connecting the radio to your internet network, setting time and date, alarms, screen brightness, sleep timer, equalizer, and more... From the home menu screen, rotate the DIAL and select “Configuration”.

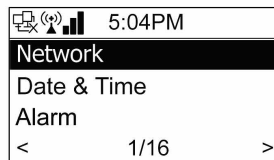
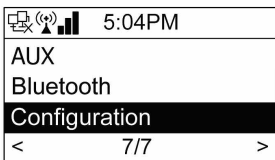

## Setting up the radio on an internet network:

---

“Network” will display options for connecting the radio to your internet network. There are several options for connecting depending on your network capabilities. In most cases connecting wirelessly is the preferred method.

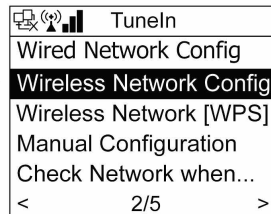
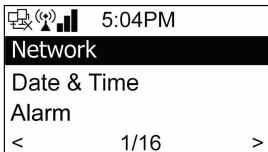

## Configuring your radio

---

- **“Wired Network Configuration”** Connect to your network using a USB-To-Ethernet adapter or ethernet cable.  
(Optional - Sold separately.)
- **“Wireless Network Configuration”** will guide you through the process of scanning for nearby wireless networks and connecting to them. Refer to page 9 for more details.
- **“Wireless Network [WPS PBC]”** is the easiest way to connect to your internet router, provided that your router has a button for WPS also. After selecting this option, press the button on your router to finalize the connection.
- **“Manual Configuration”** lets you set up your own IP information depending on your network’s custom configuration. This is mostly for advanced users who are familiar with their network setup.
- **“Check Network When Power On”** will maintain a connection to your network all the time. When the power button is pressed, your internet radio station will connect and play faster.

### Setting the date and time:

---

- **“Set Date and Time”** - Rotate the dial or use the up and down arrows on the remote control to modify each highlighted section. Press the right or left arrows to select the next or previous section to modify. Sections include month, day, year, hour, minute, AM/PM.

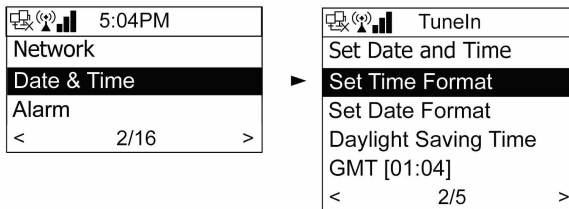

Press the SELECT or OK button to save.

## Configuring your radio

---

- **“Set Time Format”** – Choose between 12 and 24 hour time. 12 hour time uses AM/PM (for USA), 24 hour time is often referred to as military time or world time. Rotate the dial to highlight your section, then press the SELECT button to save.
- **“Set Date Format”** – Choose the format in which the date is viewed. In the USA we view month first, then day, then year (MM/DD/YYYY). Other parts of the world will display the day or year first. Rotate the dial to highlight your section, then press the SELECT button to save.
- **“Daylight Saving Time”** – Choose to turn daylight saving time “On” or “Off”. Rotate the dial to highlight your section, then press the SELECT button to save.
- **“GMT”** will display the “Greenwich Mean Time” or time in London England. GMT has become adopted as a global time standard. This selection cannot be modified. It will only display the current GMT time.

### Setting the Alarm:

---

“Alarm” will display options for setting two regular alarms, a nap alarm, and the loudness of the alarm.

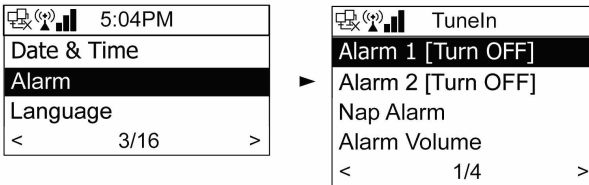

- **“Alarm 1” and “Alarm 2”** –
  1. After selecting “Alarm 1” or “Alarm 2”, rotate the dial and select “Turn On” (selecting “Turn Off” will disable the alarm).
  2. Modify the days that the alarm will sound by choosing “Repeat”. Rotate the DIAL and press the SELECT button to choose your selected days for the alarm to sound. Press the left arrow button to go back to previous screen.

## Configuring your radio

---

3. Rotate the dial and choose “Time”. Rotate the dial to choose the hour, then press the right arrow once. Rotate the dial again to choose minutes. Press the right arrow again. Choose AM or PM and press the SELECT button when finished.
4. Rotate the dial and choose “Sound”. Now you can choose a buzzer alarm, melody alarm, TuneIn radio preset, or FM radio preset to wake to. Rotate the DIAL and make your selection by pressing the SELECT button. Press the “Home” button to exit Alarm setup or left arrow to go back.

*Note: When the alarm is set, you will notice a small icon at the top of the screen. When the radio is in standby mode, the alarm time will show at the bottom of the screen in world time format.*

- “**NAP Alarm**” can be used to quickly set a short alarm time up to two hours. Rotate the dial and choose how long you will nap for, then press the SELECT button to save.
- “**Alarm Volume**” – Rotate the DIAL to choose your desired volume level for all radio alarms.

### **Choosing a Language:**

---

There are 11 languages to choose from on this radio. Only the screen will display a different language; the radio stations will not change. Rotate the dial and choose your desired language, then press the select button. In case an unknown language is selected and you cannot return to English, press the HOME button once, then choose option 7/7, then choose option 4/16, then option 1/11.

### **Setting the Screen Brightness:**

---

Choose “Dimmer” to adjust the brightness of the screen. There are two modes, “Turn On” and “Power Saving”. Notice which mode is currently active by the dot next to it.

- “**Turn On**” will adjust the normal brightness of the screen when the radio is on. When this mode is selected, then the screen will maintain the same brightness while the radio is on.

## Configuring your radio

---

- **“Power Saving”** will allow you to adjust the brightness of the screen when the radio is turned off. If this mode is selected, the screen will maintain this brightness all the time, whether the radio is on or off.
- **“Dimmer Timer”** will only work while “Power Saving” mode is selected. Choose how much time will pass before the screen brightness changes from “Turn On” brightness to “Power Saving” brightness. For example: If the dial or other button is pressed, then the screen will use the “Turn On” brightness level and then return to the power saving brightness level after 30 seconds of inactivity.

### ***Power Management:***

---

Choose how much time will expire before the radio will automatically power down to save power. This setting will only take effect if there is no volume or play is stopped.

### ***Sleep Timer:***

---

Listen to the radio as you fall asleep. After the set amount of time the radio will turn itself off to give you better rest. Quickly set the sleep timer using the “ZZZ” button on the remote control. Press “ZZZ” button again to sleep longer. An icon will display at the top of the screen showing time remaining until the radio turns off.

### ***Buffer:***

---

The buffer is the amount of time that the radio pre-records an internet radio station before playing it. This buffer helps keep the station playing smoothly, even if there are tiny gaps in the station stream. A shorter buffer time will play the station quicker after it is selected because there is not as much pre-recording time involved. A longer buffer may help for stations with choppy streams.

### ***Weather:***

---

Choose a nearby large city and get weather updates and forecasts that display on the standby screen while radio is off.

## Configuring your radio

---

- **“Show on Standby”** – when this setting is “ON” the current weather will display on the standby screen when the power is off. The standby screen will interval between time and weather every 10 seconds. Press the SELECT or OK button to quickly interval between time and weather. While viewing weather on the standby screen, press the right or left arrow to cycle through the forecasts for later dates. The current temperature will update only once a day for smaller cities. Large cities such as New York or Los Angeles will update the temperature every 2 hours.
- **“Temperature Unit”** will let you choose between Centigrade and Fahrenheit temperature units depending on your preference.
- **“Set Location”** – Choose your desired continent, then country, then city. Only 200 cities are displayed per country, so you may need to select the closest large city instead of your exact location.

### *FM Setup:*

---

Choose to listen to FM radio in mono or stereo. Also, it is possible to listen to frequencies below the normal USA band by choosing the Japan band.

### *Playback Setup:*

---

Set files that are playing from UPnP or USB to repeat or shuffle playback mode.

### *Login Tunein:*

---

Associate your radio with a free Tunein.com account. You can then add favorite stations to your radio using your computer. See page 15 for more details.

### *Equalizer:*

---

Adjust the sound by selecting an equalizer setting. You can choose from Normal, Flat, Jazz, Rock, Movie, Classical, Pop, or News. Typically, talk radio sounds best when using the “News” setting. Quickly access the equalizer settings at any time by pressing the EQ button on the remote control.

## Configuring your radio

---

### ***Resume When Power On:***

---

The radio is designed to resume play of the last station when it is powered “on”. If there is a power outage in the middle of the night, and then the power is restored, the radio will automatically start playing the last station at previous volume level. As you can imagine, this could disturb your sleep and may even be frightening. Change this setting to “Off” to have the radio go to standby mode when power is restored after an outage.

### ***Software Update:***

---

This setting allows the radios software to be updated if needed. Check [www.ccrane.com](http://www.ccrane.com) to see if there are any updates available. You will need a USB flash drive and a computer with internet connection to apply software updates. Software updates are not required.

### ***Reset to Default:***

---

Restore the radio back to factory settings. This will erase all information on the radio including presets and network settings. In some cases, this will correct problems or settings that are having a negative effect on how the radio is operating.

## Troubleshooting FAQ's

---

**Q: Is there a quicker way to get back to the main menu screen?**

A: On the radio, press the Home button/knob once or the “house icon” button on the remote control with the house icon.

**Q: How can I quickly return to the currently playing station when I am in a menu?**

A: On the radio, press the Home button/knob two times or the “house icon” button on the remote control two times.

**Q: I don't remember my wireless network password. How do I find it?**

A: It may be possible to use your computer to find your wireless network password if your computer connects to the same network wirelessly. For Windows Vista, Windows 7, and Windows 8 computers, the password is stored in “Manage Wireless Networks” in the “Network and Sharing center”. You will need to look at the properties for the selected wireless connection. Also, see the internet for more help finding your lost wireless password using your computer. In some cases, where your internet service provider has supplied you with a wireless router, the password may be printed on the bottom. If your router is store-bought then this is not likely.

**Q: When I turned the radio on it was unable to locate my network when scanning. What do I do?**

A: The radio may have missed your network when scanning or possibly your network is having trouble. Try unplugging power from the radio for 10 seconds, then return power and see if your network is found. If the problem continues then check your network with a computer to see if it is functioning properly.



## Optional Accessories

---

Available at [ccrane.com](http://ccrane.com) or call: 1-800-522-8863



**USB to Ethernet Adapter**  
*Item # U2EA*



**SoftSpeaker™ -2 Pillow Speaker**  
with Volume Control  
*Item # SSV*



**CC Buds Earphones**  
*Item # CCBUDS*



**1/8" to 1/8" Stereo 6' patch Cord**  
*Item # STC*

**NOTE:**

Changes or modifications not expressly approved by the party responsible could void the user's authority to operate this device.

**NOTE:** This equipment has been tested and found to comply with the limits for a Class B digital device, pursuant to Part 15 of the FCC Rules. These limits are designed to provide reasonable protection against harmful interference in a residential installation. This equipment generates, uses and can radiate radio frequency energy and, if not installed and used in accordance with the instructions, may cause harmful interference to radio communications. However, there is no guarantee that interference will not occur in a particular installation.

If this equipment does cause harmful interference to radio or television reception, which can be determined by turning the equipment off and on, the user is encouraged to try to correct the interference by one or more of the following measures:

- Reorient or relocate the receiving antenna.
- Increase the separation between the equipment and receiver.
- Connect the equipment into an outlet on a circuit different from that to which the receiver is connected.
- Consult the dealer or an experienced radio/TV technician for help.

Copyright © 2014

by C. Crane

1001 Main St, Fortuna, CA 95540

Phone: 1-800-522-8863

Web: [ccrane.com](http://ccrane.com)

All rights reserved. No part of this booklet may be reproduced, in any form or means whatsoever, without permission in writing from C. Crane.

Model: CC Wifi2

ANSI C63.4: 2003

THIS DEVICE COMPLIES WITH PART 15 OF THE FCC RULES.  
OPERATION IS SUBJECT TO THE FOLLOWING TWO CONDITIONS:

- 1) THIS DEVICE MAY NOT CAUSE HARMFUL INTERFERENCE.
- 2) THIS DEVICE MUST ACCEPT ANY INTERFERENCE RECEIVED,  
INCLUDING INTERFERENCE THAT MAY CAUSE UNDESIRE  
OPERATION.

Notice: Any changes or modifications not expressly approved by the party responsible for compliance could void the user's authority to operate the equipment.